

**2 x 3/4 in. Carbon Steel, Forged Bushing.  
 3000 lb Rating, Threaded Connection,  
 Reducing. ANSI B1.201**



<u>Item No.</u>	M118951	<u>UOM</u>	EA
-----------------	---------	------------	----

[View Product Online to Request Quote](#)

**Specifications**

Type	Bushing
Item Remarks	Reducing
Size	2 x 3/4 in.
Material	Steel
Material Grade	Carbon Steel, Forged
Pressure Class	3000 lb
Connection	Threaded
Specification	ANSI B1.20.1
Market	Commercial

Product URL: <https://torksystems.com/M118951>

# Forged Steel Fittings

# Plugs & Bushings - ASME B16.11

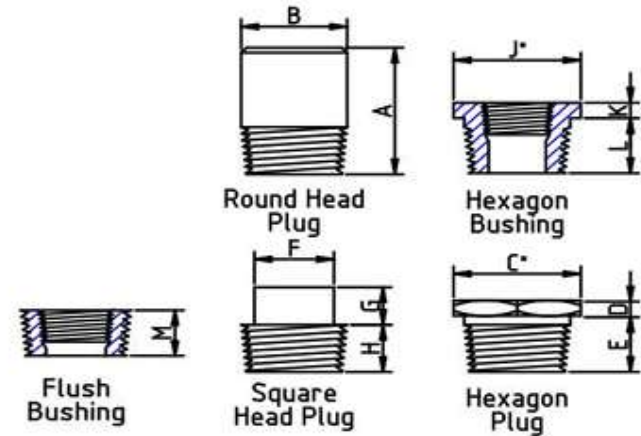

### Threaded

CLASS	DIMENSIONS	SIZES (INCHES)											
		1/8	1/4	3/8	1/2	3/4	1	1 1/4	1 1/2	2	2 1/2	3	4
3000/6000	A	1 3/8	1 5/8	1 5/8	1 3/4	1 3/4	2	2	2	2 1/2	2 3/4	2 3/4	3
	B	13/32	9/16	11/16	13/16	1 1/16	1 5/16	1 11/16	1 29/32	2 3/8	2 7/8	3 1/2	4 1/2
	C	7/16	5/8	11/16	7/8	1 1/16	1 3/8	1 3/4	2	2 1/2	3	3 3/4	4 7/8
	D MIN.	1/4	1/4	5/16	5/16	3/8	3/8	9/16	5/8	11/16	3/4	13/16	1
	E	7/16	1/2	9/16	11/16	3/4	27/32	7/8	15/16	1	1 1/4	1 11/16	1 25/32
	F	9/32	3/8	7/16	9/16	5/8	13/16	15/16	1 1/8	1 5/16	1 1/2	1 11/16	2 1/2
	G	1/4	1/4	5/16	3/8	7/16	1/2	9/16	5/8	11/16	3/4	13/16	1 1/4
	H	3/8	7/16	1/2	9/16	5/8	3/4	13/16	13/16	7/8	1 1/16	1 1/8	1 1/4
J MIN		3/16	3/16	3/16	1/4	1/4	3/8	3/8	3/8	1/2	7/16	1	
ROUND PLUG	WEIGHT	0.05	0.11	0.18	0.25	0.41	0.73	1.20	1.57	3.10	5.01	7.40	13.25
HEXAGON PLUG	WEIGHT	0.03	0.06	0.09	0.16	0.27	0.48	0.93	1.35	2.26	3.84	7.08	12.07
SQUARE PLUG	WEIGHT	0.02	0.04	0.06	0.12	0.19	0.35	0.61	0.83	1.41	2.33	3.57	6.28
HEX BUSHING	WEIGHT		0.03	0.04	0.06	0.12	0.21	0.38	0.37	0.77	1.31	3.78	7.31
FLUSH BUSHING	WEIGHT		0.05	0.07	0.03	0.06	0.09	0.17	0.19	0.39	0.62	1.00	1.88