



8 in. 304SS, 316SS Gate Valve. Class 150 Rating, Flanged Connection, Outside Stem & Yoke (OSY)

<u>Item No.</u>	M102133	<u>UOM</u>	EA
-----------------	---------	------------	----

[View Product Online to Request Quote](#)

Specifications

Type	Gate Valve
Item Remarks	Outside Stem & Yoke (OSY)
Size	8 in.
Material	Stainless Steel
Material Grade	304SS, 316SS
Pressure Class	Class 150
Connection	Flanged
Specification	ANSI B16.5
Market	Commercial

Product URL: <https://torksystems.com/M102133>

OVC# SS150GT

Class 150 Stainless Steel Gate Valve

Features

- Design: API 603
- Face to face: ASME B16.10
- Flange dimension: ASME B16.5
- Test: API 598

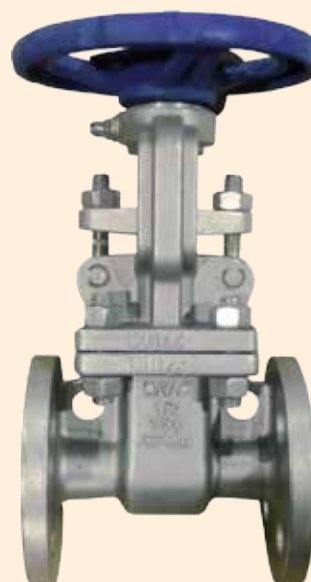
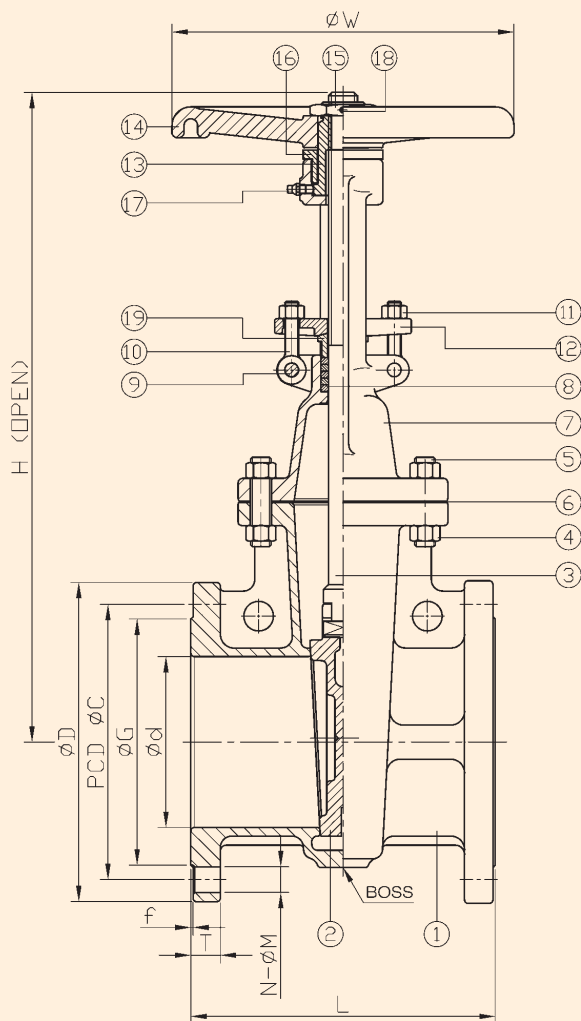

NO.	DESCRIPTION	MATERIAL
1	BODY	ASTM A315-CF8M
2	DISC	ASTM A315-CF8M
3	STEM	ASTM A276-316
4	NUT	ASTM A194-8
5	STUD	ASTM A193-B8
6	GASKET	PTFE
7	BONNET	ASTM A351-CF8M
8	PACKING	PTFE
9	PIN	AISI 316
10	EYE BOLT	ASTM A193-B8
11	NUT	ASTM A194-8
12	GLAND FLANGE	AISI 304
13	STEM BUSHING	A439 D2C
14	HANDWHEEL	ASTM A536 60-40-80
15	HANDWHEEL NUT	AISI 304
16	FLAT WASHER	BRONZE
17	NIPPLE	AISI 304
18	SOCKET SET SCREWS	AISI 304
19	GLAND	AISI 304

NPS	d	G	C	D	L	H	W	T	f	N	M	Wt./Lbs.
1/2"	0.5	1.37	2.37	3.54	4.25	7.70	4.72	0.44	0.08	4	0.63	7.1
3/4"	0.75	1.69	2.75	3.94	4.61	8.33	4.72	0.44	0.08	4	0.63	8.8
1"	1	2.00	3.13	4.33	5.00	8.92	4.72	0.44	0.08	4	0.63	11.5
1-1/2"	1.50	2.87	3.87	4.92	6.50	11.71	7.87	0.58	0.08	4	0.63	18.7
2"	2	3.63	4.75	5.91	7.01	14.09	7.87	0.64	0.08	4	0.75	27.3
2-1/2"	2.5	4.13	5.5	7.09	7.5	15.2	7.87	0.7	0.08	4	0.75	36.4
3"	3	5	6	7.48	8	18.31	9.84	0.77	0.08	4	0.75	50.7
4"	4	6.19	7.5	9.06	9	21.81	9.84	0.96	0.08	8	0.75	82.7
5"	5	7.31	8.5	10.04	10	26.77	11.81	0.94	0.08	8	0.89	on request
6"	6	8.5	9.5	11.02	10.5	28.82	11.81	1.02	0.08	8	0.89	130.1
8"	8	10.63	11.75	13.58	11.5	36.73	13.78	1.14	0.08	8	0.89	201.7
10"	10	12.70	14.25	15.94	13	43.97	15.75	1.20	0.08	12	1	320.8
12"	12	15.00	17.00	19.09	14	52.45	17.72	1.27	0.08	12	1	446.4

* Other sizes available upon request.

TOLL FREE (877) 423-2660 • (513) 752-5600 • FAX (513) 752-8267
 EMAIL sales@ohiovalve.com • WEB www.ohiovalve.com